

Article number: 0106043

Description: Retaining ring JV 26

Measures

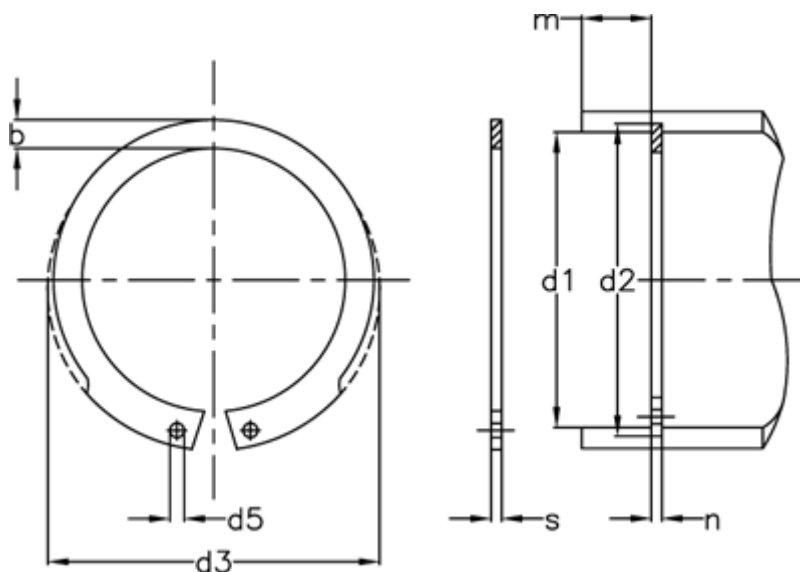

AN mm ²	= 25	FRg kN	= 5.2	tol	= 0.1
b	= 3.0	FR kN	= 15.3	tol	= -0.06
d1	= 26	g	= 1.0	tol	= +0,42-0,21
d2	= 27.2	K kN-mm	= 31.4	tol	= +0,21
d3	= 27.9	m min	= 1.30	Tong	= ZGJ-1
d5 min	= 1.5	Nominal drive	= 2.1	Weight kg/1000	= 1.50
Description	= JV 26	s	= 1.20		
FN kN	= 4.17	t	= 0.60		